

SPICE thermal model

PSMN1R0-25YLD

Symbol	Parameter	Conditions	Min	Typ	Max	Unit
$R_{th(j-mb)}$	thermal resistance from junction to mounting base		-	-	0.77	K/W

C_{th1}	6.173E-05 F
C_{th2}	4.038E-04 F
C_{th3}	4.402E-04 F
C_{th4}	3.645E-03 F
C_{th5}	6.241E-03 F
C_{th6}	1.545E-02 F
C_{th7}	2.051E-01 F
R_{th1}	1.358E-03 Ω
R_{th2}	2.432E-03 Ω
R_{th3}	1.963E-02 Ω
R_{th4}	2.968E-02 Ω
R_{th5}	1.383E-01 Ω
R_{th6}	5.182E-01 Ω
R_{th7}	6.197E-02 Ω

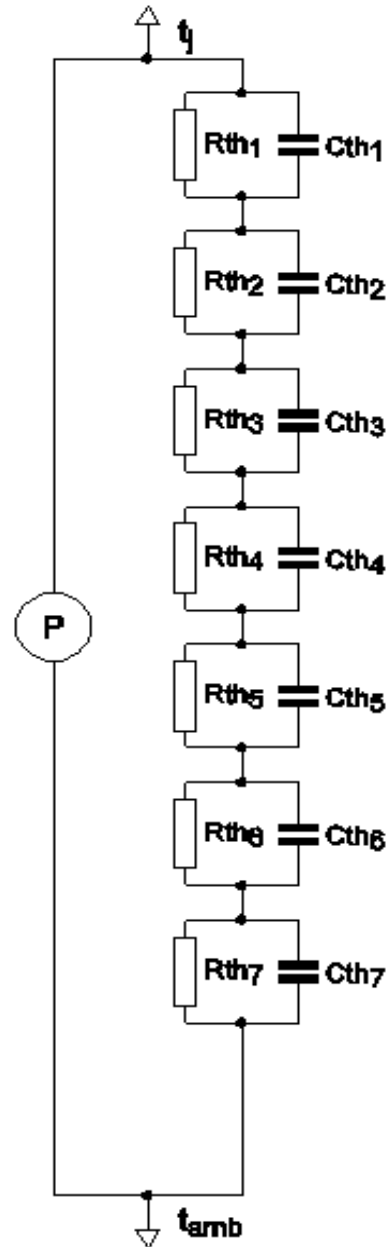

Part: PSMN1R0-25YLD
 Date: 21/3/2016
 Model Rth 0.77 K/W